

#A914BYW-100M=P3

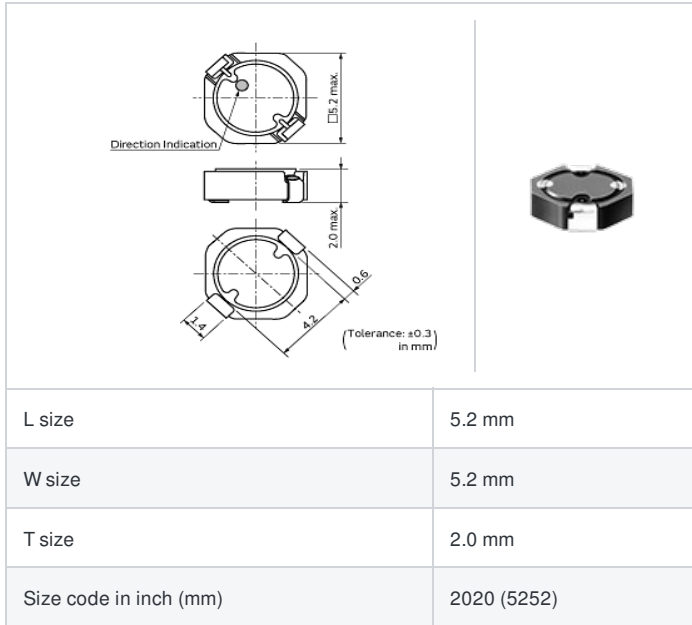

< List of part numbers with package codes >
#A914BYW-100M=P3

Shape



Notes

Rated current (I_{sat}) is specified when the decrease of the initial inductance value at 30%.
Rated current (I_{temp}) is specified when temperature of the inductor is raised 40°C by DC current.

References

Packaging code	Specifications	Minimum quantity
=P3	φ330mm Embossed taping	2000

Mass (Typ.)	
1 piece	0.138g

Specifications

Inductance	10μH ±20%
Inductance test frequency	0.1MHz
Rated current (I _{sat}) (Based on Inductance change)	760mA
Rated current (I _{temp}) (Based on Temperature rise)	930mA
Max. of DC resistance	0.15Ω
Operating temperature range (Self-temperature rise is included)	-40 to 85°C
Class of magnetic shield	Ferrite Core
Series	D52LC

Attention

- 1.This datasheet is downloaded from the website of Murata Manufacturing Co., Ltd. Therefore, it's specifications are subject to change or our products in it may be discontinued without advance notice. Please check with our sales representatives or product engineers before ordering.
- 2.This datasheet has only typical specifications because there is no space for detailed specifications. Therefore, please review our product specifications or consult the approval sheet for product specifications before ordering.

Chart of characteristic data (The charts below may show another part number which shares its characteristics.)

▪ Inductance-Current characteristics (Typ.)

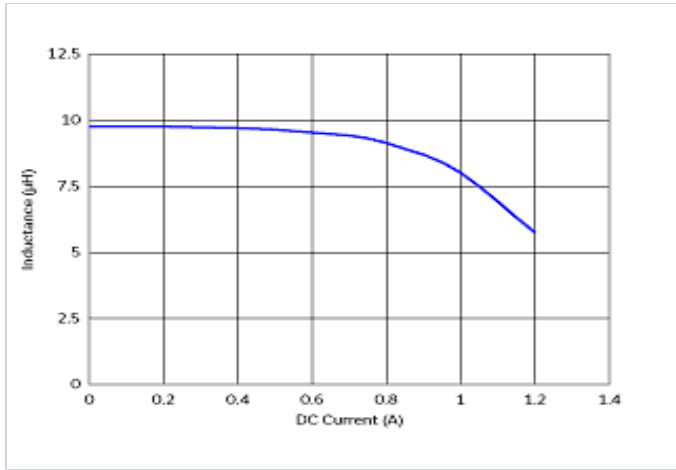

▪ Temperature rise characteristics (Typ.)

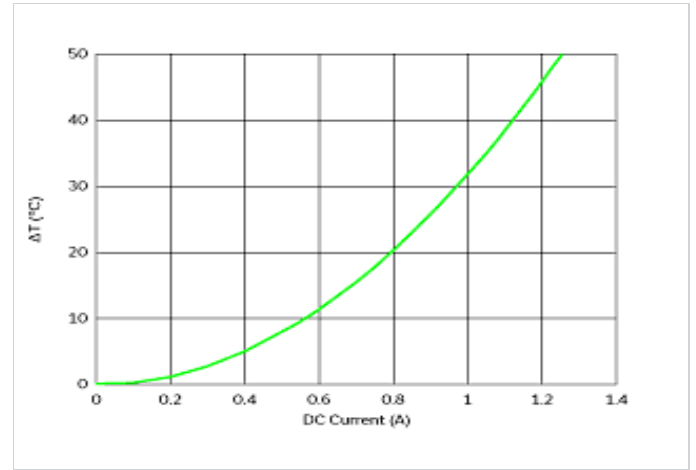

⚠ Attention

- 1.This datasheet is downloaded from the website of Murata Manufacturing Co., Ltd. Therefore, it's specifications are subject to change or our products in it may be discontinued without advance notice. Please check with our sales representatives or product engineers before ordering.
- 2.This datasheet has only typical specifications because there is no space for detailed specifications.
Therefore, please review our product specifications or consult the approval sheet for product specifications before ordering.